

① Ventilator oben
Fan on top

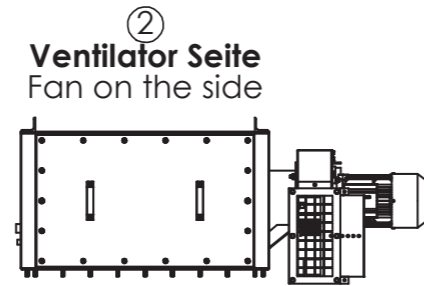

② Ventilator Seite
Fan on the side

③ Staubaustragstrichter mit Absperrklappe und Staubsammeltopf
Dust hopper with butterfly valve and dust bin

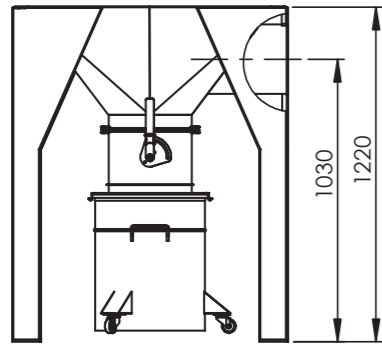

④ Staubaustragstrichter mit Staubsammeltopf
Dust hopper with dust bin

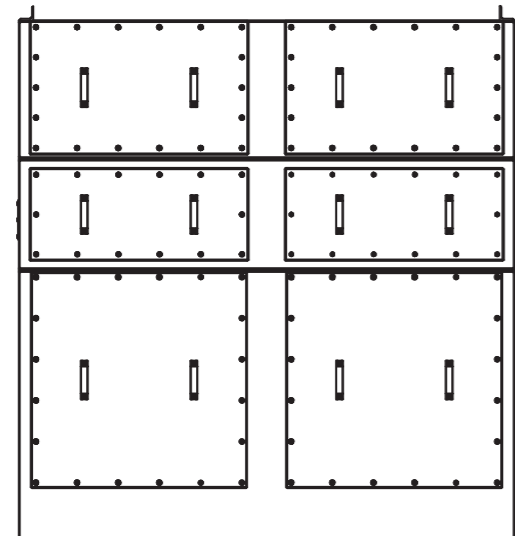
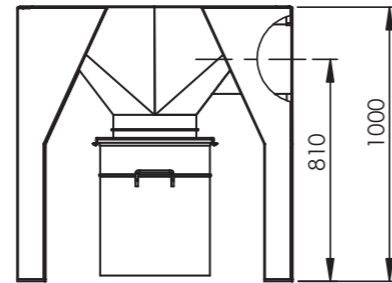

Mehrkammer Varianten möglich
Multi-chamber variants possible

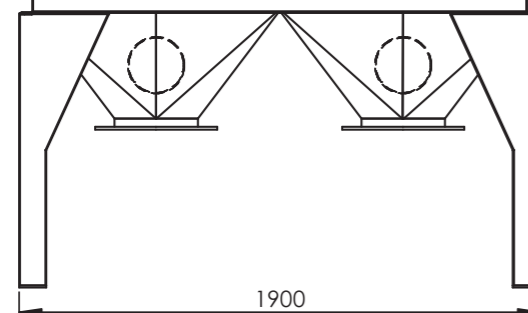

Weiteres Zubehör/Other accessories
s. Reg 1+2+3+4/see chapter 1+2+3+4
*Steuergerät/Control unit
*Wartungseinheit/Maintenance unit
*Schalldämpfer/Silencer

Konstruktionsänderungen vorbehalten!
Dimensions subject to alterations!

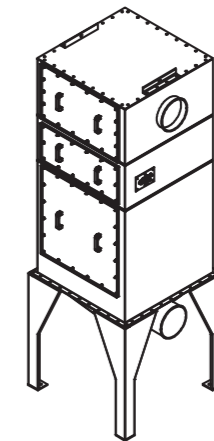
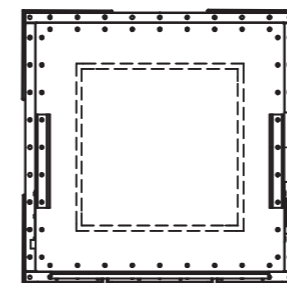
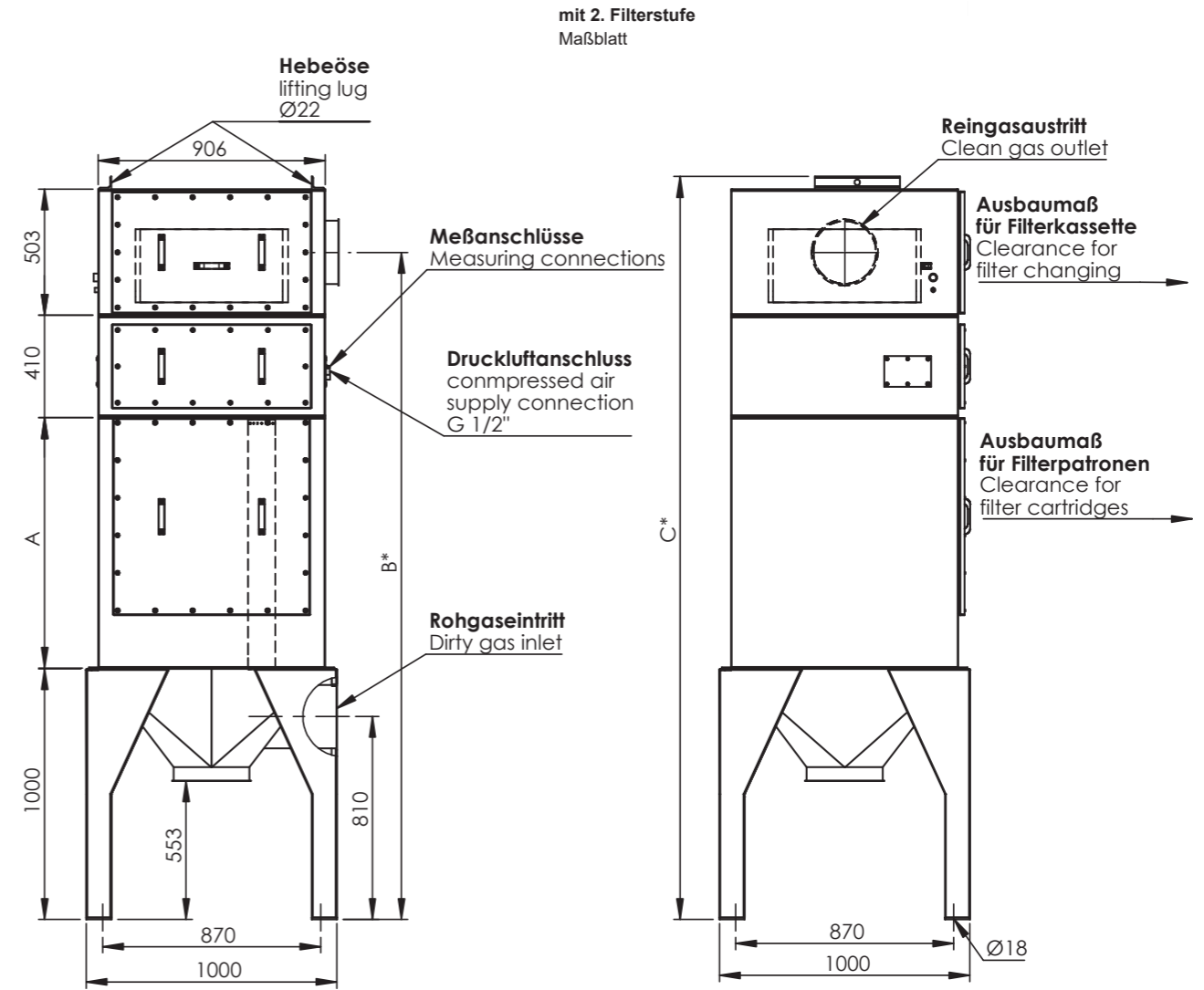

Filtertyp Type	Filterfläche Filter area	Anzahl Patronen Nr. cartridges	Gewicht Weight	A	B*	C*
IPF 1/161 D	16 m ²	9	380 kg	500	2160	2466
IPF 1/211 D	21 m ²	12	400 kg	500	2160	2466
IPF 1/321 D	32 m ²	9	460 kg	1000	2660	2966
IPF 1/421 D	42 m ²	12	490 kg	1000	2660	2966
IPF 1/451 D	45 m ²	9	540 kg	1400	3160	3466
IPF 1/601 D	60 m ²	12	580 kg	1400	3160	3466

* bezogen auf Staubaustrag ④