

Maßblatt

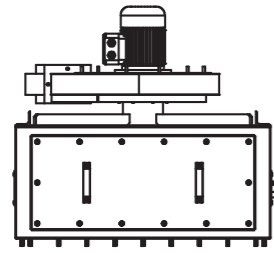

① Ventilator oben
Fan on top

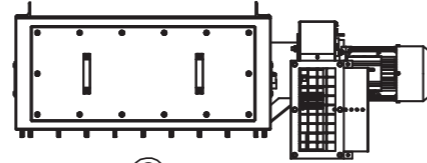

② Ventilator Seite
Fan on the side

③ Staubaustragstrichter mit Absperrklappe und Staubsammeltopf
Dust hopper with butterfly valve and dust bin

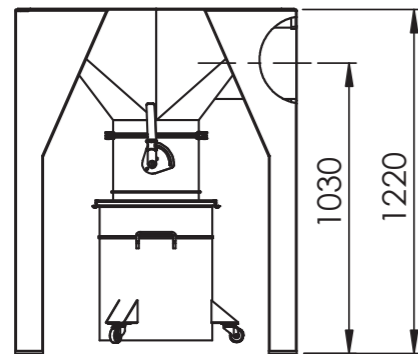

④ Staubaustragstrichter mit Staubsammeltopf
Dust hopper with dust bin

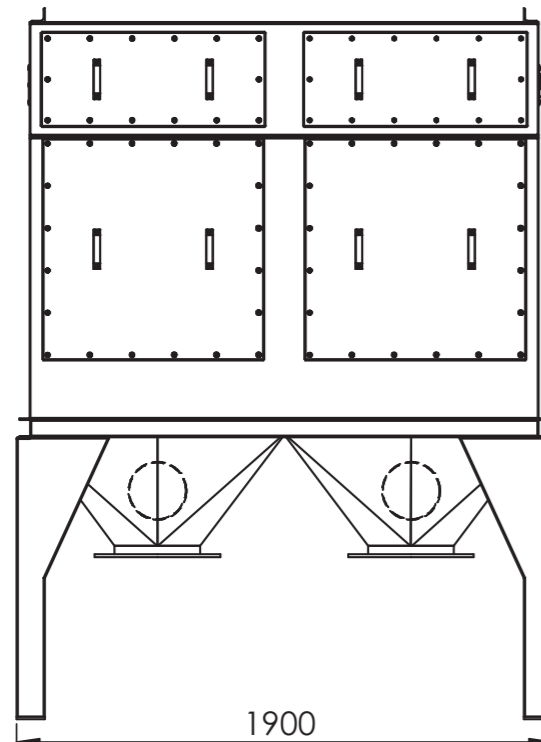
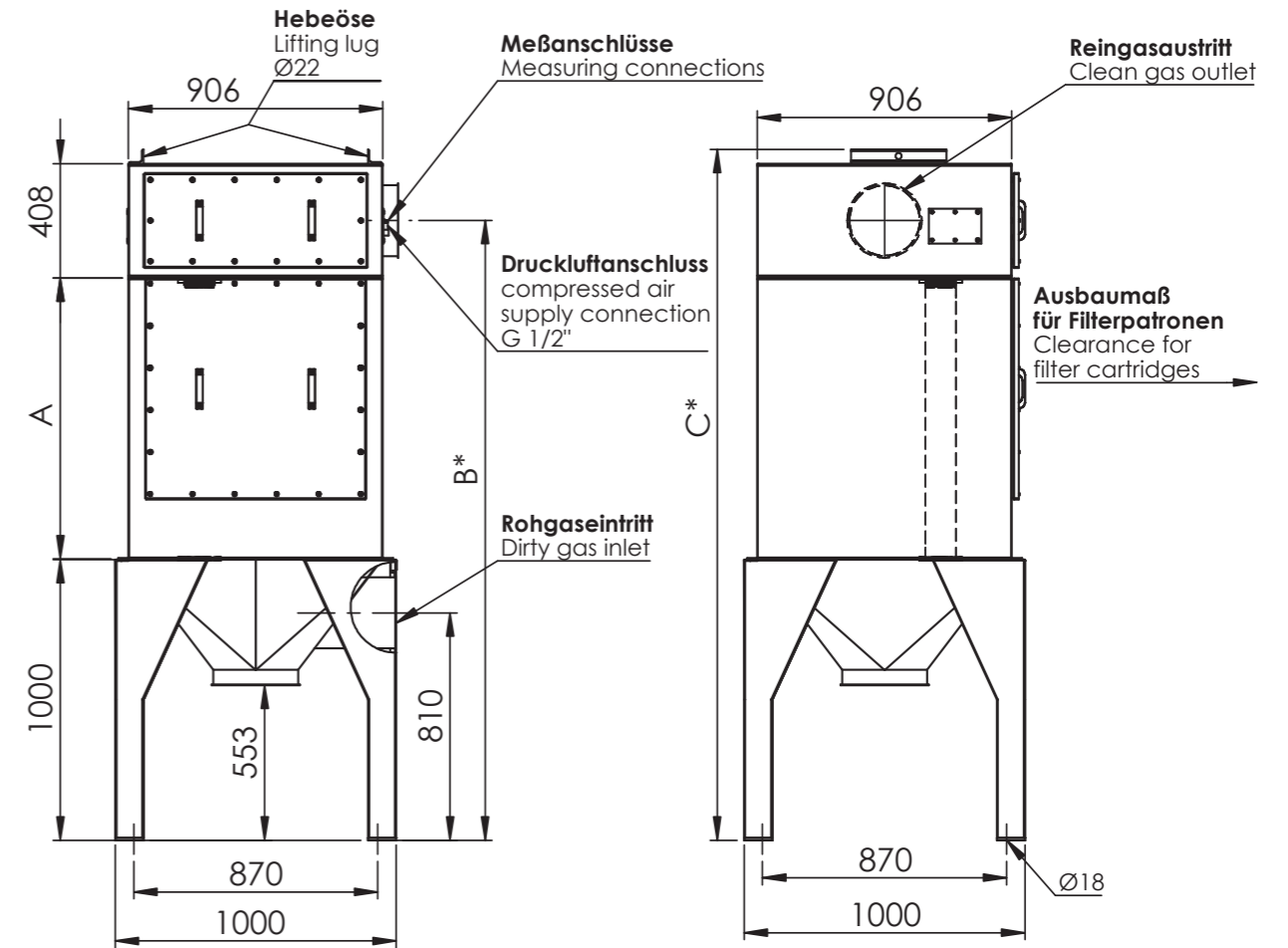
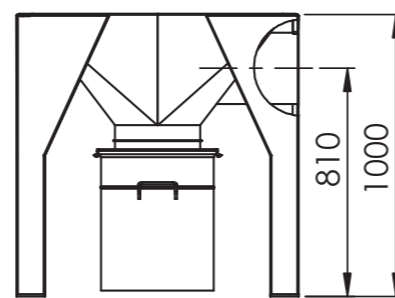

Mehrkommer Varianten möglich
Multi-chamber variants possible

Weiteres Zubehör/Other accessories
s. Reg 1+2+3+4/see chapter 1+2+3+4
*Steuergerät/Control unit
*Wartungseinheit/Maintenance unit
*Schalldämpfer/Silencer

Konstruktionsänderungen vorbehalten!
Dimensions subject to alterations!

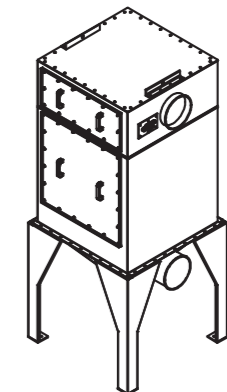
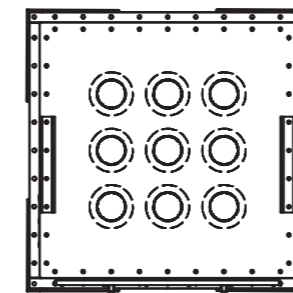

Filtertyp Type	Filterfläche Filter area	Anzahl Patronen Nr. cartridges	Gewicht Weight	A	B*	C*
IPF 1/161	16 m ²	9	290 kg	500	1708	1961
IPF 1/211	21 m ²	12	300 kg	500	1708	1961
IPF 1/321	32 m ²	9	350 kg	1000	2208	2461
IPF 1/421	42 m ²	12	380 kg	1000	2208	2461
IPF 1/451	45 m ²	9	420 kg	1400	2708	2961
IPF 1/601	60 m ²	12	460 kg	1400	2708	2961

* bezogen auf Staubaustrag ④